

Installation Manual

ArmorZone™ MASH TL-2 Portable Water-Filled Steel Longitudinal Barrier

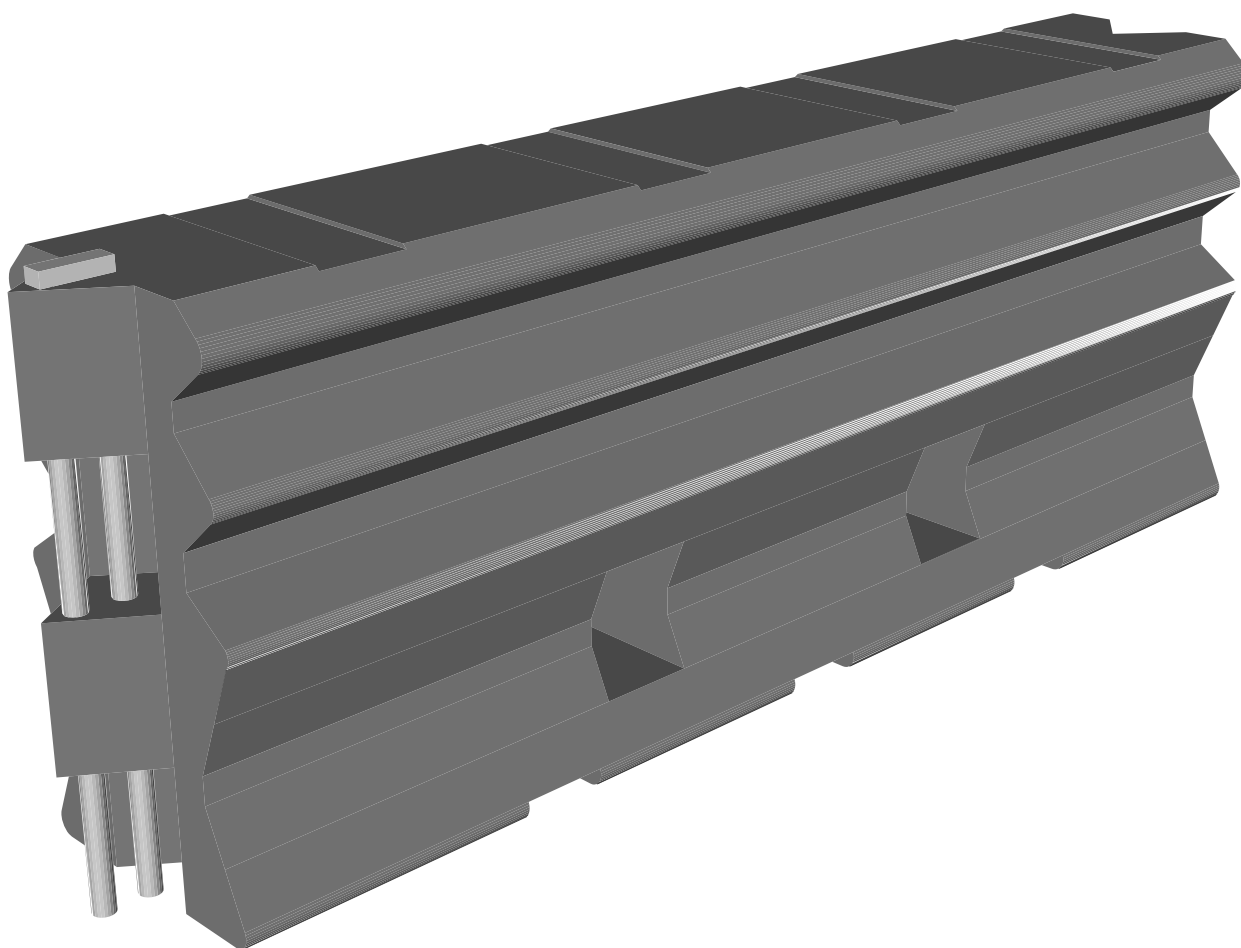

BARRIER SYSTEMS

A LINDSAY TRANSPORTATION SOLUTIONS COMPANY

BSI Customer Service Department
(888) 800-3691 [U.S. toll free] or
(707) 374-6800
Barrier Systems Sales and Service
3333 Vaca Valley Pkwy, Ste. 800
Vacaville, CA 95688
www.BarrierSystemsInc.com
e-mail: info@barriersystemsinc.com

Installation Manual

ARMORZONE PORTABLE WATER-FILLED STEEL BARRIER

Table of Contents

ArmorZone™ Introduction.....	3
System Overview.....	3
Before Installation.....	3
Limitations & Warnings.....	4
Safety Statements.....	4
System Design & Design Considerations.....	5
Parts Identification.....	6
Bill of Materials.....	6
Installation Preparation.....	7
Installation Instructions.....	8
Installation Examples.....	12
Installation Checklists.....	13
Maintenance & Repair	14
Frequently Asked Questions	15
Crash Test Result Summary.....	16

APPENDIX – Technical Drawings

ArmorZone™ Barrier.....	18
ArmorZone™ End Treatment.....	19

Installation Manual

ARMORZONE PORTABLE WATER-FILLED STEEL BARRIER

Introduction

ArmorZone™ is a TL-2 barrier made up of plastic units that when joined together using a steel pin and filled with water provides positive work zone barrier protection to temporary construction sites and other miscellaneous roadside activities.

The unique **ArmorZone™** polyethylene composition, profile design and steel pin allow the barrier to be installed straight or down to a minimum radius of 28m (92') if required.

If required the **ArmorZone™** TL-2 barrier connects directly to the **ArmorZone™** TL-2 end treatment which negates the need to shield or flare the ends of the barrier.

ArmorZone™ barrier has been designed and tested to meet the evaluation criteria of MASH Test Level 2 (TL-2) for longitudinal barriers and the end treatment to NCHRP 350 Test Level 2 (TL-2) for crash cushions.

When correctly installed the systems are capable of stopping, containing or re-directing an errant vehicle in a safe manner under MASH and NCHRP 350 impact conditions.

System Overview

ArmorZone™ TL-2 barrier and end treatment are designed and constructed to provide acceptable structural adequacy, minimal occupant risk and safe trajectory as set forth in MASH for longitudinal barriers and NCHRP 350 for crash cushions.

When impacted with 820kg, 2000kg or 2270kg vehicles at speeds of 70kph and angles up to 25 degrees, the impacting vehicle is stopped, re-directed or contained in a safe manner.

Before Installation

Placement of **ArmorZone™** shall be in accordance with the design as provided for the temporary work zone. Installation shall be in accordance with the installation instructions supplied for this product.

Depending on the circumstances at the site, installation including the filling of a unit (using a truck mounted water tanker) should take no more than 1 minute for each 2.0m unit.

ArmorZone™ is a highly engineered safety device made up of a relatively small number of parts. Before starting installation ensure that one is familiar with the make up of the system.

Installation Manual

ARMORZONE PORTABLE WATER-FILLED STEEL BARRIER

Limitations and Warnings

ArmorZone™ TL-2 barrier and end treatment have been rigorously tested and evaluated per the evaluation criteria in the MASH guidelines for longitudinal barrier and NCHRP 350 guidelines for crash cushions. The impact conditions recommended are intended to address typical in-service collisions.

When properly installed and maintained **ArmorZone™** TL-2 barrier and end treatment allows an impacting vehicle to be stopped, contained or re-directed in a safe and predictable manner under the MASH and NCHRP 350 impact conditions.

Vehicle impacts that vary from the MASH and NCHRP 350 impact conditions described for longitudinal barriers and crash cushions may result in significantly different results than those experienced in testing. Vehicle impact characteristics different than, or in excess of, those encountered in compliance testing (weight, speed and angle) may result in system performance that may not meet the evaluation criteria.

The **ArmorZone™** barrier can be installed with the **ArmorZone™** end treatment. If this treatment is not used the end of the barrier must be shielded or flared as per Road Controlling Authority requirements.

Safety Statements

General Safety

- All required traffic safety precautions should be complied with. All workers should wear required safety clothing. (high visibility vests, steel capped footwear, gloves etc.)
- Only authorized trained personnel should operate any machinery. Where overhead machinery is used, care must be taken to avoid any overhead hazards.
- Gloves should be worn at all times.

ArmorZone™ Safety Statements

- All installers must be well clear of the water tanker when the units are being filled.
- **ArmorZone™** is a stand alone barrier and does not require at any stage during installation that the surrounding soil is dug or drilled in anyway.
- The empty units weigh 58kg (128 lbs) each and should be unloaded by 2 personnel. Do not attempt to lift a unit which contains water.
- Final positioning of the empty units and placement of the steel pin connectors should be done by 1 personnel so as to remove the risk of hands and fingers being caught between the components.

Installation Manual

ARMORZONE PORTABLE WATER-FILLED STEEL BARRIER

Slopes

A maximum slope of 10:1 is preferable.

On slopes greater than this, follow the Road Controlling Authority's guidelines.

Curbs

ArmorZone™ has been designed and tested so the centre of gravity of the impacting vehicle is a constant height in relation to the barrier. For this reason, it is preferred that curbs or channels are not in front or behind the barrier as they will result in altering the height of the vehicle at impact. If there is no option but to install **ArmorZone™** near a curb, consult Road Controlling Authority's guidelines.

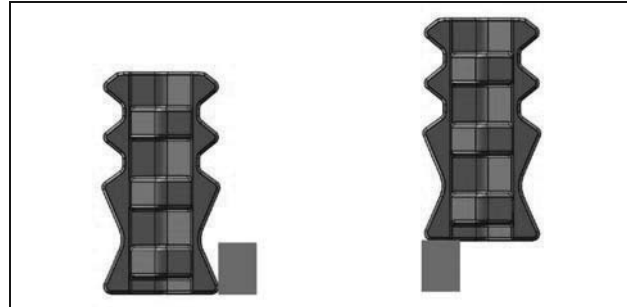

Undulating ground conditions

Site specific grading may be necessary to ensure that there are no “humps” or “hollows” that may significantly alter the impacting vehicles stability or substantially alter the barrier height in relation to the ground.

Median and Roadside Applications

ArmorZone™ can be used in both ‘roadside’ and ‘median’ applications.

Length of Need

The Length of Need (LoN) of **ArmorZone™** is 14m (46’). Ensure that when installing the barrier that it is of sufficient length. For further details consult the Road Controlling Authority's guidelines. If an **ArmorZone™** end treatment is connected the LoN increase to 16m (52’).

End Treatment

ArmorZone™ end treatment is a free standing ‘special’ end unit that can be fitted to the **ArmorZone™** barrier in a tangent position if an end treatment is required. If an end treatment is not used it may be required to flare or shield the barrier as per Road Controlling Authority's guidelines.

Soil Conditions

ArmorZone™ is installed above ground so soil conditions on site are not applicable. However it is recommended **ArmorZone™** systems are installed on a compacted surface.

System Design & Design Considerations cont

Installation Manual

ARMORZONE PORTABLE WATER-FILLED STEEL BARRIER

Deflection

Test 2-11 2270kg pickup truck, 25 degree angle at 70kph (MASH TL-2)

Dynamic Deflection 4.10m
Permanent Deflection 2.10m

Test 2-10 820kg car, 20 degree angle at 70kph (NCHRP 350 TL-2)

Dynamic Deflection 1.05m
Permanent Deflection 1.05m

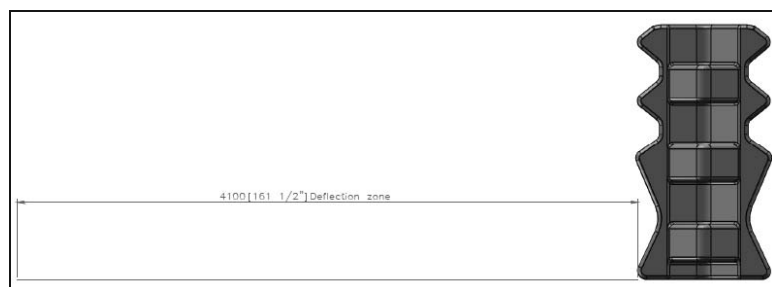

Note: Results are from actual crash testing and the test article length was 50m.

Results from **Test 2-11 (MASH)** are the published TL-2 Deflection.

Parts Identification

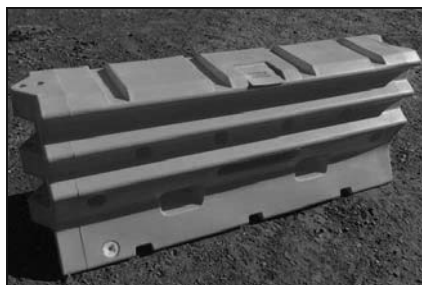

Standard Unit
(HDPE)

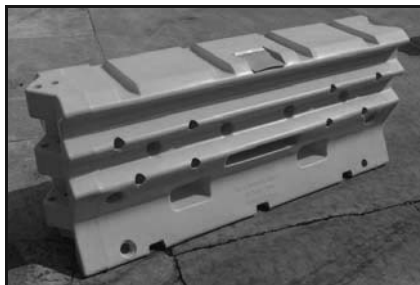

End Treatment Unit
(HDPE)

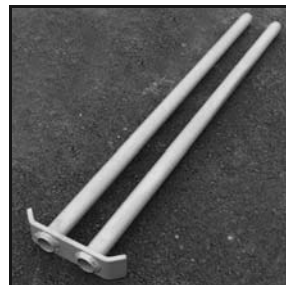

Connector
(hot dipped galvanised)

Bill of Materials

For every 2.0m (linear) of temporary barrier the following components are required:

- **2.0m ArmorZone™ Standard Unit**
1 required
- **Steel Pin**
1 required
- **Water**
440L required (116 gal)
- **2.0m ArmorZone™ End Treatment Unit & Pin**
Optional (water is not required)

Installation Manual

ARMORZONE PORTABLE WATER-FILLED STEEL BARRIER

Getting Started

It is essential that **ArmorZone™** barrier and **ArmorZone™** end treatment are installed correctly. Please carefully read and understand the following instructions before installing system.

Note: These instructions relate only to the installation of **ArmorZone™** and are for standard installations only.

ArmorZone™ is designed so that it has exactly the same components and barrier setup whether in a 'roadside' or 'median' application. For all installations, commence placement of the units at one end and connect the units together until the correct barrier length and position is achieved. Please ensure that the checklists for both barrier and end treatment are completed for every installation.

Preparation

Before installing **ArmorZone™**, ensure that all components required for the system are on site and have been identified. **ArmorZone™** is a highly engineered safety device made up of a relatively small number of parts. Before starting installation ensure that one is familiar with the make up of the system. Refer to the **Parts Identification** and **Bill of Materials** section in this manual for more information.

Ensure that the area where **ArmorZone™** is to be installed is flat enough (max slope 10:1) and compacted, so that the ground conditions will not significantly alter the height of the vehicle in relation to the height of the barrier.

Minor site grading may be required.

Tools Required

There are no tools required to install the components of **ArmorZone™**. The units can be manually lifted and positioned by 2 personnel and the steel pin used to connect the units is simply dropped into position.

Each unit requires approx 440L (116 gal) of water and it is recommended that a large truck mounted tanker with large fill hose is sourced for fast barrier construction. The diameter of the 'fill hole' is 125mm (5").



Note:

The **ArmorZone™** end treatment unit is never filled with water. Through design it is not possible to hold water through error or weather conditions.

Installation Manual

ARMORZONE PORTABLE WATER-FILLED STEEL BARRIER

Standard Installation

Step 1 – Site Preparation

It is preferred that *ArmorZone*[™] barrier is installed on compacted flat, level ground.

Ensure that sufficient width and traffic control is available before installing *ArmorZone*[™]. Due to the bulky nature of the units, deployment will be from a flat deck truck or similar. Each unit requires 440L (116 gal) of water and it is recommended that a large truck mounted tanker is used.

ArmorZone[™] barrier should be installed in a tangent position to the direction of travel.

ArmorZone[™] units are dispatched in bundles of up to 15. (shown in Figure 1)

To ensure safe unloading of the units, use a fork hoist or similar to lower each row to ground level. From there each unit can be manually moved into position. (shown in Figure 2)



Figure 1.

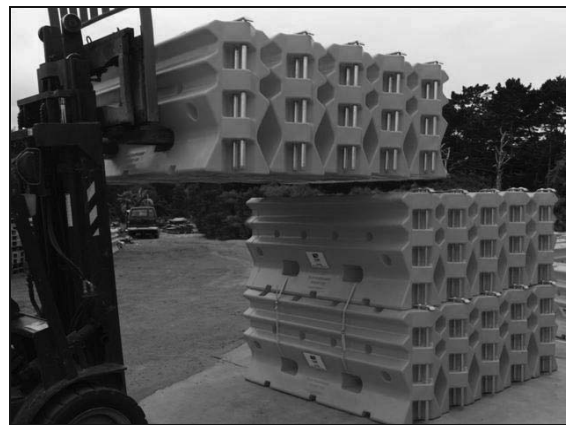

Figure 2.

Note: If the drainage bung is on the workzone side of the barrier when assembled, it will allow for safe access when decommissioning the barrier.

Installation Manual

ARMORZONE PORTABLE WATER-FILLED STEEL BARRIER

Step 2 – Placement of the Barrier Units

Unload the units and set out in a row along the intended barrier position. Make sure the configuration of the ends will fit together where they join. (shown in Figure 3)

Lifting the units is a 2 person job; they weigh 58kg (128 lbs) each when empty.

Slide the units into position. (shown in Figure 4)



Figure 3.



Figure 4.

The units must fit flush together so that the vertical holes on each unit line up. (shown in Figure 5 & 6)

Note: None of the units are fixed to the ground in any way.



Figure 5.

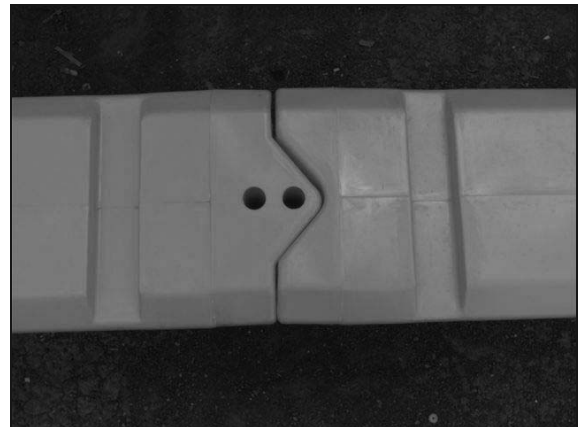

Figure 6.

Installation Manual

ARMORZONE PORTABLE WATER-FILLED STEEL BARRIER

Step 3 – Connecting the Barrier Units

Once the units are 'flush fit' aligned, the steel pin can be positioned down the 2 vertical alignment holes. (shown in Figure 7 & 8)

The steel pin sits in the vertical holes under its own weight only and is not connected to the barrier units in any other way.

Note: If slight curvature of the barrier is required, position as required at this point.



Figure 7.



Figure 8.

Step 4 – Filling the Barrier Units

Lifting the flap on the top of the unit will allow access to the 125mm(5") diameter water 'fill hole'. (shown in Figure 9)

Using a truck mounted tanker fill each unit to the top with water. (shown in Figure 10)

Check that there are no leaks before filling the next unit. If there is a leak the unit must be replaced. It may be possible to fix at a later stage depending on the damage.



Figure 9.



Figure 10.

Installation Manual

ARMORZONE PORTABLE WATER-FILLED STEEL BARRIER

Step 5 – Connecting the End Treatment Unit (Optional)

If protection is required for the end of the barrier, the *ArmorZone™* end treatment can be connected to the barrier in a tangent position.

Position the end treatment unit so that the lugs line up with the end barrier unit. Slide the unit into position so that the vertical holes line up. (shown in Figure 11 & 12)



Figure 11.



Figure 12.

Once the units are ‘flush fit’ aligned, the ‘twin pin’ connector can be positioned down the 2 vertical alignment holes. (shown in Figure 13 & 14)

Note: The end treatment unit is is not and can not be filled with water.

The connector sits in the vertical holes under its own weight only and is not connected to the barrier units in any other way.



Figure 13.



Figure 14.

Note: The end treatment unit is NOT fixed to the ground in any way and must NOT have the ‘twin pin’ connector inserted at the exposed end of the unit.

Installation Manual

ARMORZONE PORTABLE WATER-FILLED STEEL BARRIER

Step 6 – Delineation (Optional)

Depending on location, delineation may be required as per the Road Controlling Authority Guidelines.

For further details contact your *ArmorZone*™ distributor.

ArmorZone™ – Installation Examples

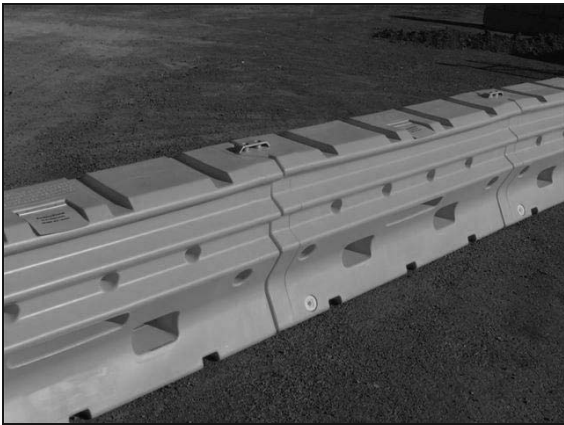

Straight Installation



Curved Installation

Note: A minimum 28m (92') radius curvature can be achieved when the 'flush fit' connection is made between *ArmorZone*™ units. It is recommended that this positioning should be completed before the units are filled with water.



Installed End Treatment

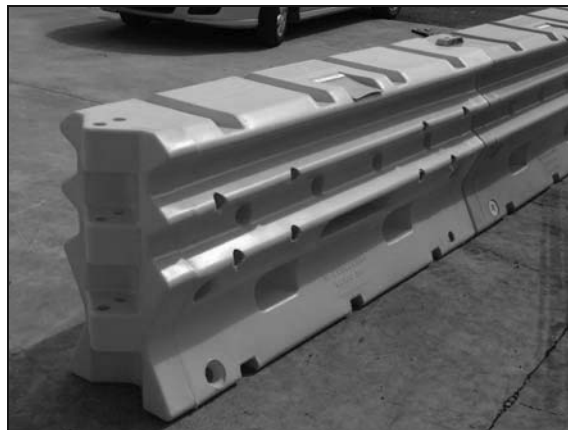

Installed End Treatment

Installation Manual

ARMORZONE PORTABLE WATER-FILLED STEEL BARRIER

INSTALLATION CHECKLIST FOR			
ArmorZone™ Barrier & End Treatment			
<i>Location</i>			
<i>Installed By</i>		<i>Date</i>	
<i>Inspected By</i>		<i>Date</i>	
			Y/N
			N/A
<p>Barrier</p> <ul style="list-style-type: none"> • The units are positioned on level ground. • The set-out of the barrier is as per the design instructions. • The lugs of each unit have a 'flush fit' with each other and the steel pin is positioned through both vertical holes in the lugs of each unit. • The lid and bung are attached to each unit correctly so as to ensure the units will remain full of water as intended. • Each unit is filled to the top with water. (approx 440L (116 gal)) Check for leaks. • The barrier is not fixed to the ground or any other device in any way. • Attach delineation as required by the Road Controlling Authority Guidelines. <p>End Treatment</p> <ul style="list-style-type: none"> • The ArmorZone™ end treatment unit is connected to the ArmorZone™ barrier using the twin pin steel connector through both vertical holes in the lugs of each unit. • The end treatment unit is not and can not be filled with water. • Do not install a twin pin connector at the upstream end of the end treatment unit. • The end treatment unit is not fixed to the ground or any other device in any way. • Attach delineation as required by the Road Controlling Authority Guidelines. 			

Installation Manual

ARMORZONE PORTABLE WATER-FILLED STEEL BARRIER

Maintenance

ArmorZone™ is a maintenance free system, although it is recommended that inspections are carried out periodically.

In extreme conditions it may be possible for evaporation to take place and it is important that the barrier units remain filled to the correct level. (water level fill indicators are optional)

It is important that the end treatment unit is in the correct position, undamaged and not filled with debris.

Repair

After a typical impact

Recommended tools:

- Flat deck truck
- A truck mounted water tanker
- A crow bar or similar

Replacement parts required for a severe impact:

- **ArmorZone™** Standard and / or End Treatment Units
- Steel Pins
- 440L (116 gal) of water for each standard unit

Key Steps:

- Separate the damaged components by removing the steel pins.
- Drain any units that are partially damaged.
- Assess which components are damaged and replace with new parts accordingly.
- Connect replacement units to the undamaged section of the barrier and align as required.
- Fit the replacement steel pins between each unit.
- Fill all the units with water to the required level.
- Connect the end treatment unit to the barrier.
- Attach delineation as required.

For further information consult the **ArmorZone™ Installation Instructions** section in the product manuals.

After fire damage

ArmorZone™ is made of polyethylene and joined together using steel pins. It is possible that under extreme conditions, like large fires, that the components of the system can be damaged. If this is the case replace the components as described above and as outlined in the **ArmorZone™ Installation Instructions** section in the product manual.

Installation Manual

ARMORZONE PORTABLE WATER-FILLED STEEL BARRIER

ArmorZone™ System – Frequently Asked Questions

1) What type of equipment is required to install ArmorZone™?

Each unit weighs 50kg (128 lbs) so can be unloaded, positioned and stacked by hand by 2 personnel. Units are connected together by simply fitting the steel pin by hand. To fill the units it is recommended that a truck mounted water tanker is used. (440L (116 gal) per unit)

2) Does your company provide spare parts? What is the lead-time for supply?

It is important to fix a damaged barrier as soon as possible because it most probably won't perform as required when damaged. All components are available from your nearest ArmorZone™ distributor.

3) On average, how long does it take to install an ArmorZone™ Barrier?

Depending on the application and circumstances at the site, installation and assembly of the system should take a 2 person crew approx. 1 hour to install a 120m (394') section.

4) What about vandalism, can ArmorZone™ be easily damaged?

The units are constructed using strong polyethylene and would not easily be damaged. The construction is similar to 'other' water filled barriers and this is not considered an issue. See separate **Assessment of Materials** report for details on vandalism.

5) How easily can ArmorZone™ be restored after impact?

The system is made up of very few components and is modular so easily repaired. A flat deck truck, crow bar and water tanker will be required to reinstate.

6) What maintenance is required? What is the expected performance life?

ArmorZone™ is a maintenance free system. For barriers installed for long periods of time or in extreme conditions, cyclic checks may be required. The **standard barrier units** must remain filled to the required level (water fill level indicators are available) and the **end treatment unit** needs to be in the correct position, undamaged and not filled with debris. See separate **Assessment of Materials** report for details on performance life.

7) What is the Deflection of ArmorZone™ Barrier?

Maximum deflection recorded during actual MASH crash testing at TL-2 was 4.1m.

8) In a leading position, how can the end of the barrier be protected?

A TL-2 **ArmorZone™** end treatment can be connected to the barrier. (NCHRP 350)

9) What is ArmorZone™ Barrier connected to?

ArmorZone™ barrier is a free standing system and is not anchored in anyway.

10) Is the performance of ArmorZone™ jeopardised when the water is frozen?

Performance of the barrier may not be as intended if the water freezes. If conditions are below zero degrees the following additives can be used to stop the water freezing. For percentages required, cost, environmental impact and reduced temperature, consultation with a third party is required.

Sodium Chloride, Calcium Chloride, Ethylene/Propylene Glycol, Liquid CMA
and Liquid Potassium Acetate.

11) Can ArmorZone™ units be moved when full?

It is possible and extreme care must be taken, a full unit weighs 498kg (1100lbs). Each unit is equipped with fork hoist holes through the barrier and must be used with the appropriate machinery and safety equipment.

Installation Manual

ARMORZONE PORTABLE WATER-FILLED STEEL BARRIER

Crash Test Result Summary

Test..... 2-10 (NCHRP 350)
Test Article..... **ArmorZone™** barrier (25 units)
CIP..... 14m downstream
Test Vehicle.... 820 kg Car (820C)
Speed..... 70 kph
Impact Angle... 20 deg (Impact Severity = 19.9kJ)



Test..... 2-11 (MASH)
Test Article..... **ArmorZone™** Barrier (25 units)
CIP..... 25m downstream
Test Vehicle.... 2270 kg Pickup Truck (2270P)
Speed..... 70 kph
Impact Angle... 25 deg (Impact Severity = 76.6kJ)



In all tests the vehicles were safely captured or re-directed by the **ArmorZone™** barrier. The vehicles did not penetrate, underride or override the test installations. The test article was judged to have satisfied the requirements of NCHRP Report 350 (820C) and MASH (2270P) at TL-2.

Installation Manual

ARMORZONE PORTABLE WATER-FILLED STEEL BARRIER

Test..... 2-40 (NCHRP 350)
Test Article..... **ArmorZone™** End Treatment
CIP..... On Nose, ¼ offset

Test Vehicle.... 820 kg Car (820C)
Speed..... 70 kph
Impact Angle... 0 deg (Impact Severity = 153.3kJ)

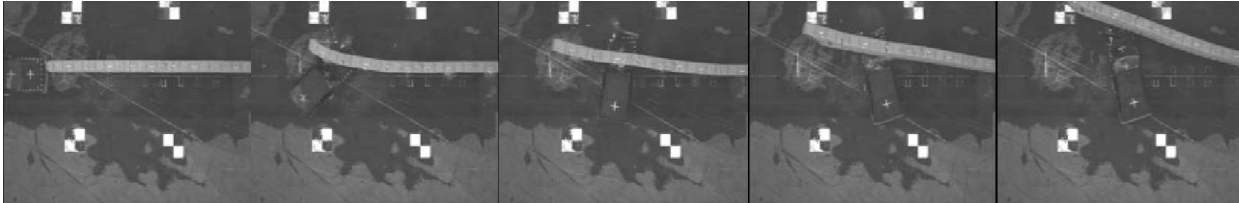

Test..... 2-41 (NCHRP 350)
Test Article..... **ArmorZone™** End Treatment
CIP..... On Nose

Test Vehicle.... 2000 kg Pickup Truck (2000P)
Speed..... 70 kph
Impact Angle... 0 deg (Impact Severity = 395.6kJ)



Test..... 2-43 (NCHRP 350)
Test Article..... **ArmorZone™** End Treatment
CIP..... On Nose

Test Vehicle.... 2000 kg Pickup Truck (2000P)
Speed..... 70 kph
Impact Angle... 15 deg (Impact Severity = 368.4kJ)



In all tests the vehicles controlled and occupant risk values were within the preferred limits. The test article was judged to have satisfied the requirements of NCHRP Report 350 at TL-2.

Installation Manual

ARMORZONE PORTABLE WATER-FILLED STEEL BARRIER

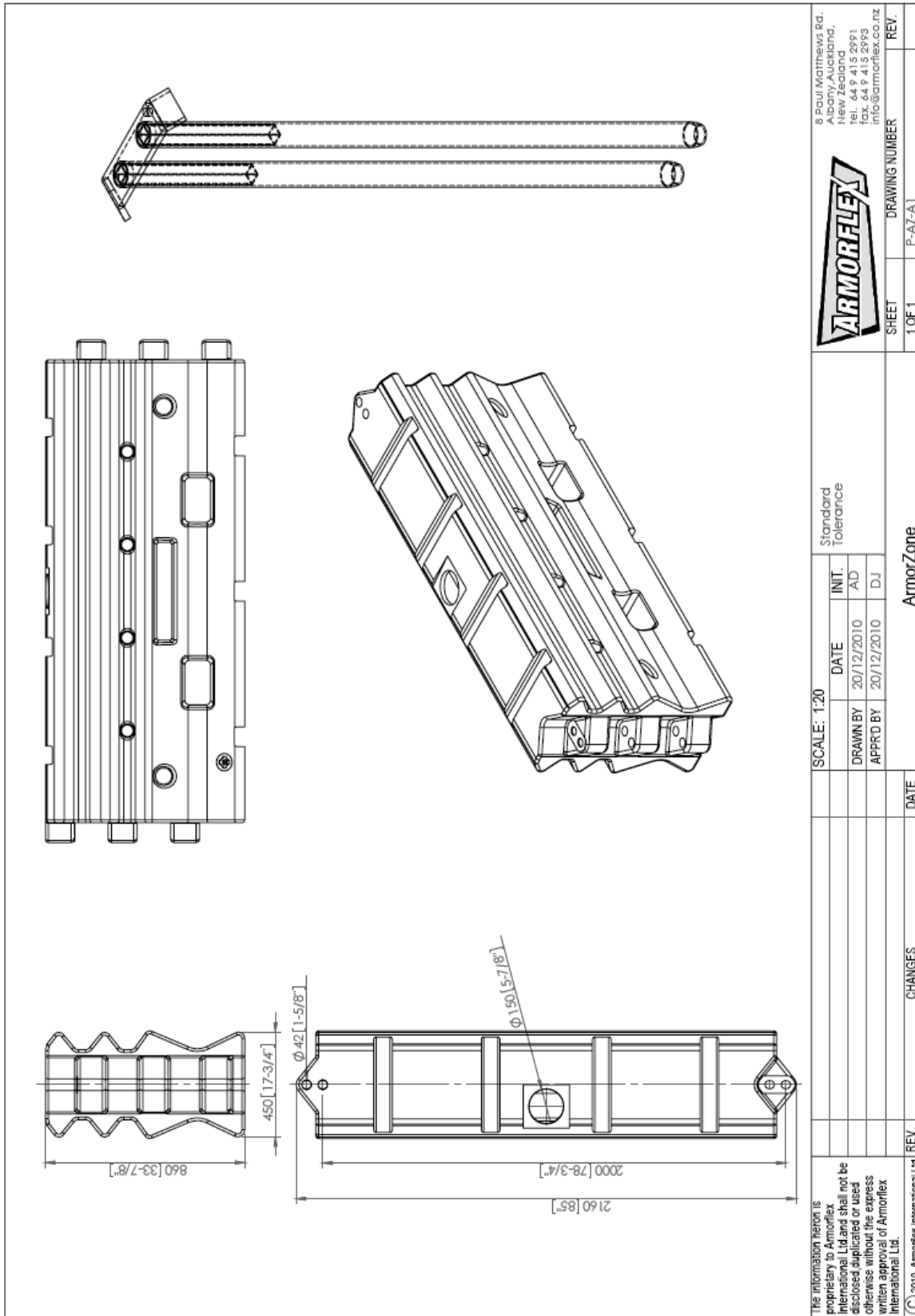

ArmorZone™ Barrier – Plan, Elevation, Isometric & Pin

Installation Manual

ARMORZONE PORTABLE WATER-FILLED STEEL BARRIER

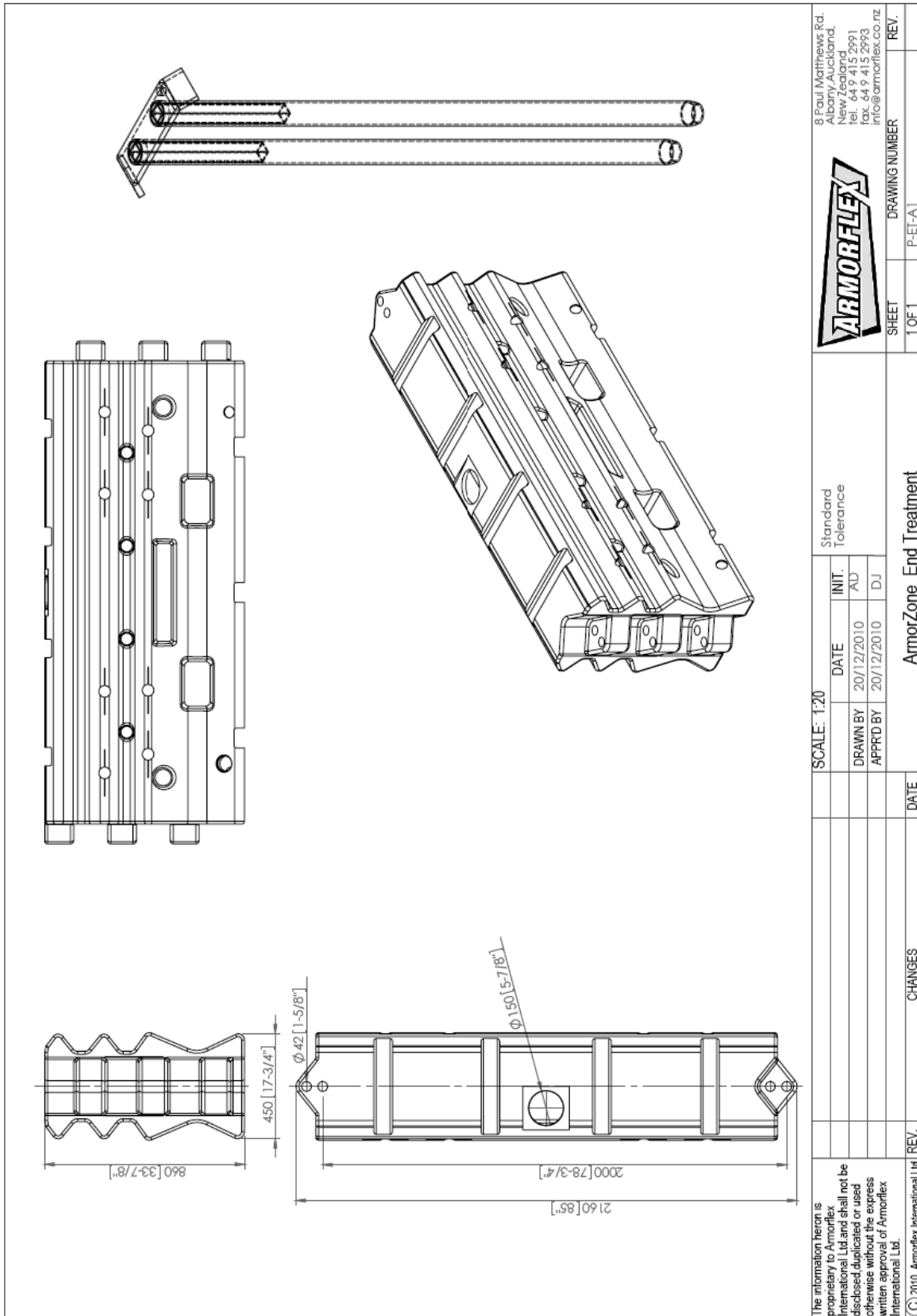

		8 Paul Matthews Rd. Albany Auckland, New Zealand tel. 64 9 415 2991 fax. 64 9 415 2993 info@armorflex.co.nz	
SHEET	DRAWING NUMBER	REV.	REV.
1 OF 1	P-ET-A1		
SCALE: 1:20 Standard Tolerance		ArmorZone End Treatment	
DRAWN BY	DATE	INIT.	REV.
APPRD BY	20/12/2010	AD	DJ
DATE	CHANGES	REV.	REV.

The information herein is proprietary to Armorflex International Ltd and shall not be disclosed, duplicated or used otherwise without the express written approval of Armorflex International Ltd.

© 2010 Armorflex International Ltd

ArmorZone™ End Treatment – Plan, Elevation, Isometric & Pin

